

WITHIN SCHOOL ZONE

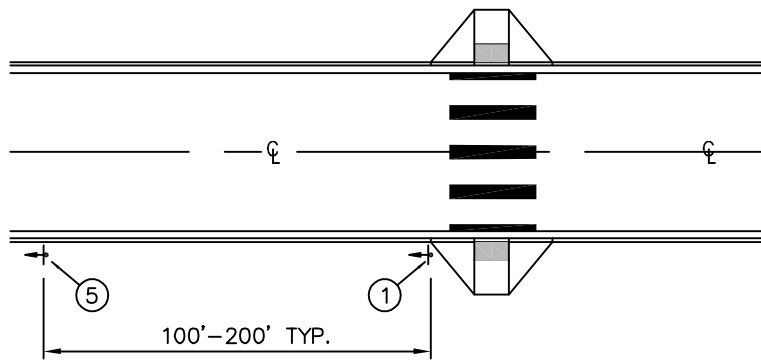

OUTSIDE SCHOOL ZONE

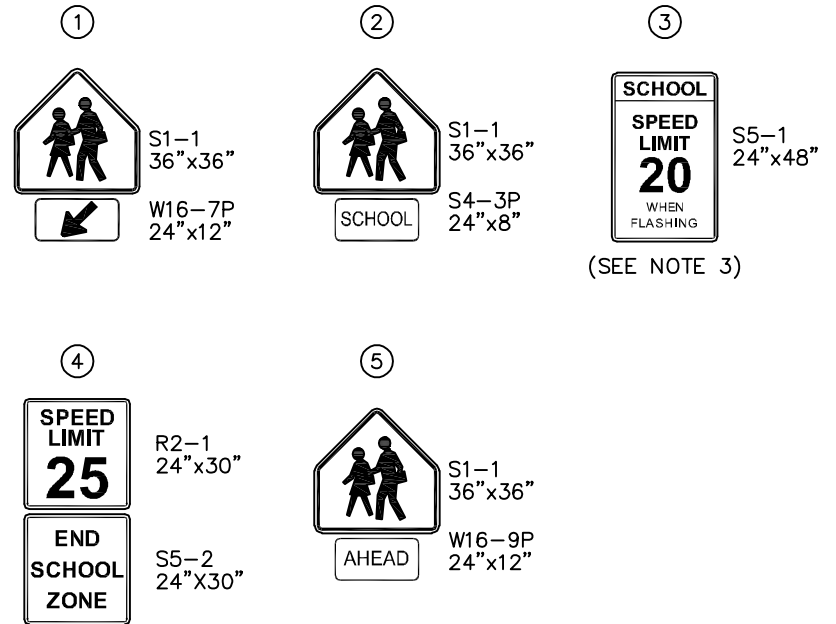

(SEE NOTE 3)

NOTES:

1. SIGN COMBINATIONS ①, ②, ⑤, THE "SCHOOL" LEGEND ON SIGN ③ AND ANY ADDITIONAL PLAQUES SHALL BE FLUORESCENT YELLOW-GREEN WITH BLACK LEGEND AND BORDER.
2. SEE STD. DWG. CW-100-1 FOR CROSSWALK MARKINGS.
3. IN SCHOOL SPEED ZONES WITHOUT FLASHING BEACONS, USE BOTTOM MESSAGE "WHEN CHILDREN ARE PRESENT" OR AS DIRECTED BY THE ENGINEER.
4. IF ROADWAY BORDERS A SCHOOL, THIS DISTANCE MAY INCREASE AS PER RCW 46.61.440.



AT GRADE SCHOOL CROSSWALK SIGNING

DRAWING NUMBER	CW-170-1
SCALE	NONE
REVISION DATE	1/25
DEPARTMENT	TRANS