

**NOTES:**

1. APPLY WELD CAP DIRECTLY TO PIPE, NOT TO PIPE WRAP. USE PRIMER AS REQUIRED BY THE MANUFACTURER.
2. COMPLETELY ENCLOSE WIRE WITHIN WELD CAP.
3. REPAIR ANY DAMAGED COATING NOT COVERED BY WELD CAP.

**EXOTHERMIC WELD DI & STEEL PIPE**

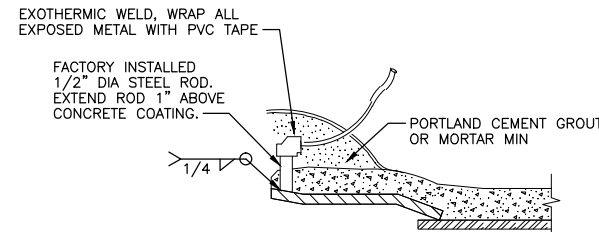

**EXOTHERMIC WELD MCSP & CCP PIPE**

FOR PIPING RUNS GREATER THAN OR EQUAL TO 100 FEET

PIPE DIAMETER	NUMBER OF ANODES
LESS THAN OR EQUAL TO 16"	1 PER 100 FT (2 MIN)
18" TO 30"	2 PER 100 FT
GREATER THAN OR EQUAL TO 32"	4 PER 100 FT

**NOTES:**

1. RUNS OF PIPE SHALL HAVE AN ANODE INSTALLED AT EACH END.
2. ANODES TO BE SPACED A MIN OF 5 FT APART.
3. ANODES ALONG A RUN OF PIPE SHALL BE EVENLY DISTRIBUTED AND LOCATED ADJACENT TO A PIPE JOINT.

FOR PIPING RUNS LESS THAN 100 FEET INSTALL ANODE AT EACH END OF RUN

PIPE DIAMETER	NUMBER OF ANODES
LESS THAN OR EQUAL TO 16"	2 (1 AT EACH END)
GREATER THAN OR EQUAL TO 18"	4 (2 AT EACH END)

**ANODE SCHEDULE**

**NOTES:**

1. LOCATE ANODES A MAX OF 3 FEET HORIZONTALLY FROM CENTERLINE OF PIPE.
2. PLACE GALVANIC ANODE IN CLEAN NATIVE BACKFILL AND COMPACT TO 12" ABOVE ANODE.
3. ANODES MAY BE PLACED UPRIGHT OR HORIZONTALLY, HORIZONTAL ORIENTATION SHOWN.
4. ANODE WIRE SHALL BE EXOTHERMIC WELDED DIRECTLY TO PIPE OR INCORPORATED INTO THE JOINT BOND WITH A SPLIT-BOLT CONNECTION.

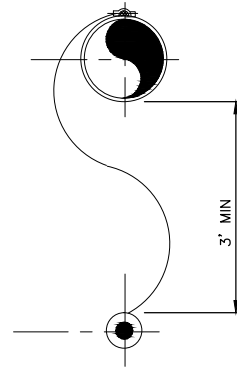

**GALVANIC ANODE 1**  
SCALE: NTS

**GALVANIC ANODE INSTALLATION**

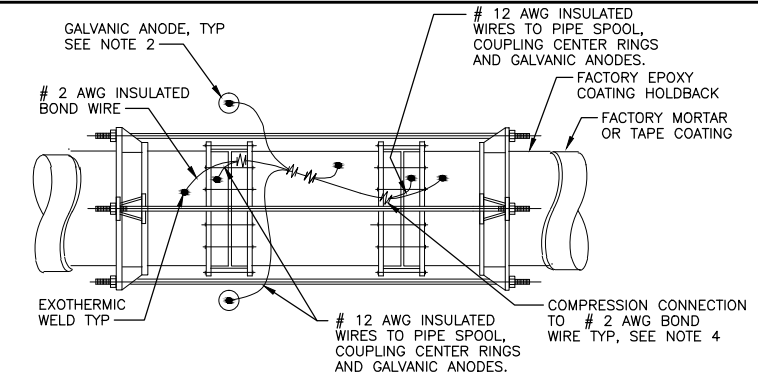

**NOTES:**

DOUBLE FLEX COUPLING SHOWN, SINGLE FLEX COUPLING SIMILAR. ONE JOINT BOND ASSEMBLY SHOWN, TWO REQUIRED

**JOINT BOND**

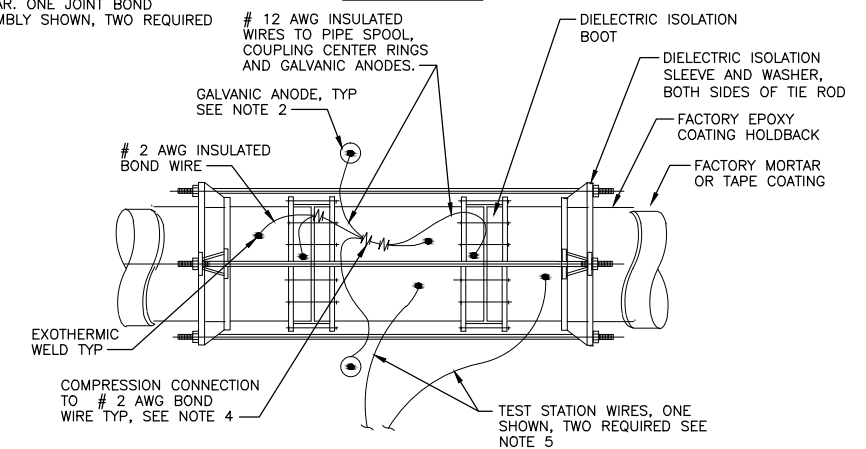

**NOTES:**

DOUBLE FLEX COUPLING SHOWN, SINGLE FLEX COUPLING SIMILAR. ONE JOINT BOND ASSEMBLY SHOWN, TWO REQUIRED

**ISOLATION JOINT**

**NOTES:**

1. FACTORY EPOXY COAT PIPE, HOLD BACK AREA, LUGS, SPOOL AND FLEXIBLE COUPLINGS.
2. TWO ANODES SHOWN, PROVIDE FOUR ANODES TOTAL, TWO EACH JOINT BOND ASSEMBLY.
3. WAX TAPE COAT THE ENTIRETY OF THE JOINT INCLUDING THE HOLD BACK AREA, THE SPOOL, THE COUPLINGS, THE HARNESS LUGS AND TIES. WAX TAPE SYSTEM SHALL INCLUDE PETROLATUM PRIMER, PETROLATUM PROFILING MASTIC, PETROLATUM TAPE, AND STRETCH FILM OVERWRAP. PROVIDE PROFILING MASTIC TO COAT COUPLINGS AND FILL POCKETS IN HARNESS RINGS AND LUGS.
4. WRAP ELECTRICAL COMPRESSION CONNECTIONS WITH TWO LAYERS OF SELF FUSING BUTYL RUBBER ELECTRICAL INSULATING TAPE AND TWO LAYERS OF VINYL ELECTRICAL TAPE.
5. TEST STATIONS, REFERENCE ELECTRODES AND COUPONS NOT SHOWN.

**RESTRAINED FLEX COUPLING CORROSION PROTECTION 3**  
SCALE: NTS

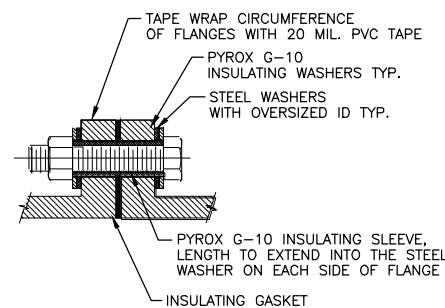

**DIELECTRIC ISOLATION FLANGE JOINT DETAIL**

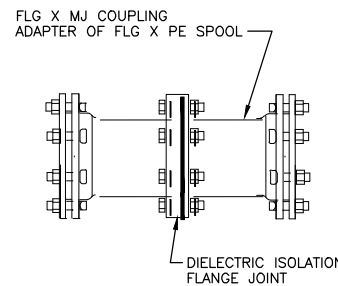

**DIELECTRIC ISOLATION FLANGE JOINT ASSEMBLY**

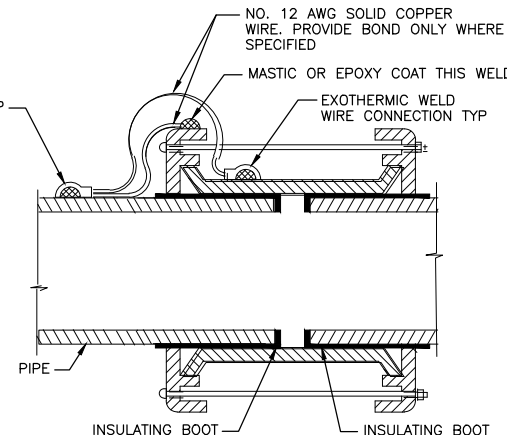

**NOTES:**

1. CENTER FLEXIBLE COUPLING OVER INSULATING BOOTS.
2. EXOTHERMIC WELD TO COUPLING PRIOR TO ASSEMBLY. DO NOT BURN BOOTS.
3. BOND THE COUPLING TO A PROTECTED SIDE OF THE JOINT WHERE SPECIFIED.

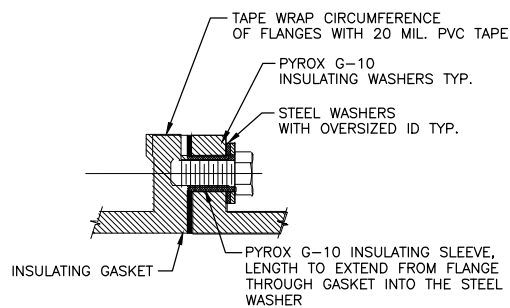

**DIELECTRIC ISOLATION FLANGE JOINT TAP SCREW DETAIL**

**DIELECTRIC ISOLATION FLEXIBLE COUPLING 2**  
SCALE: NTS

January 2023

DESIGNED	ACE	APPROVED	
DRAWN	ACE	SCALE	AS SHOWN
DATE		DATE	AUG 2012
NO.		FILE	X
REVISIONS			
BY	ACE		

0 1" IF THIS BAR IS NOT ONE INCH, THEN ADJUST SCALES ACCORDINGLY

**ACE**  
Consultants, Inc.  
Beaverton, Oregon (503) 626-2320

CITY OF BELLEVUE  
WASHINGTON

CATHODIC PROTECTION  
STANDARD DETAIL - EL - 3