

DRILL & TAP TWO
5/8"-11NC HOLES
THRU FRAME

LEVELING PAD
7-7/8" X 3/4" X 2 1/4"
(TYP.)

PLAN

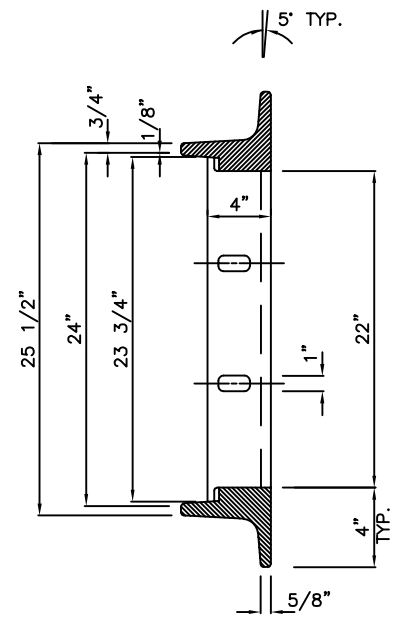

SECTION B-B

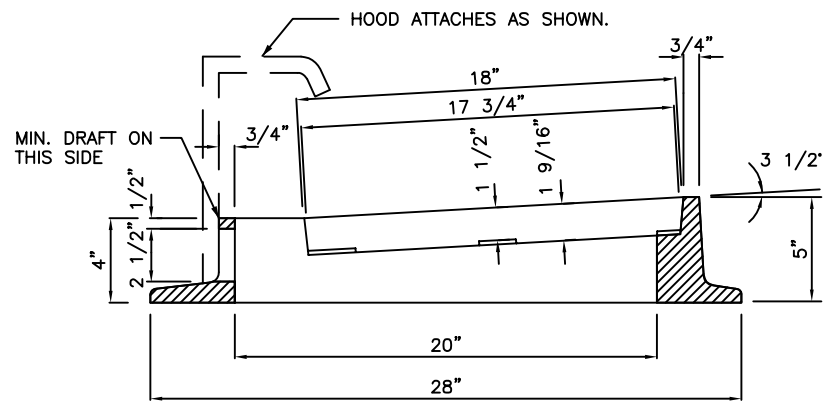

SECTION A-A

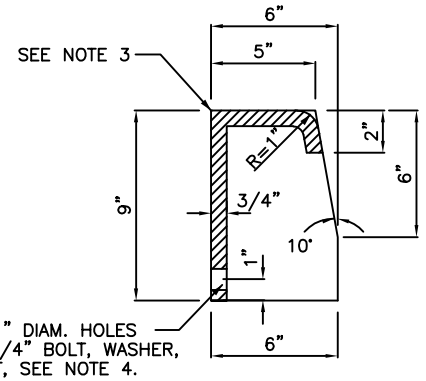

SECTION C-C

NOTES:

1. MATERIAL SHALL CONFORM TO SECTION 9-05.15(2) OF THE STANDARD SPECIFICATIONS.
2. PATTERN ON TOP SURFACE OF HOOD SHALL BE 3/16" NON-SKID DIAMOND.
3. BOLT, WASHER, AND NUT SHALL BE GALVANIZED OR CORROSION RESISTANT.
4. SEE DETAIL D-11 FOR INSTALLATION.

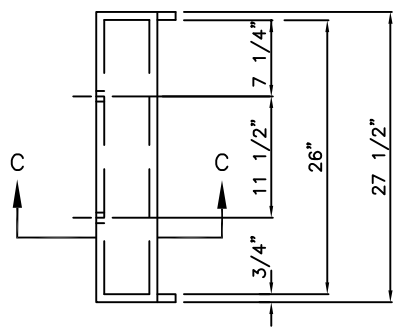

HOOD DETAIL



City of
Bellevue

STORM AND SURFACE
WATER UTILITY

TITLE

THROUGH-CURB
INLET FRAME